

KH-3518-R15

SPECIFICATION SHEET Handmade Stainless Steel Kitchen Sink



Sink Dimensions

- Exterior Overall: 35" x 18"
- Bowl Interior: 33" x 16"

Features

- Depth: 10"
- 18 gauge / 304 stainless steel
- Drain location: Rear
- Drain opening: 3 1/2"
- Sound dampening pads
- Mounting hardware included
- Cut-out template included

Codes / Standards

- cUPC 9ASME A112.19.3/CSA B45.4

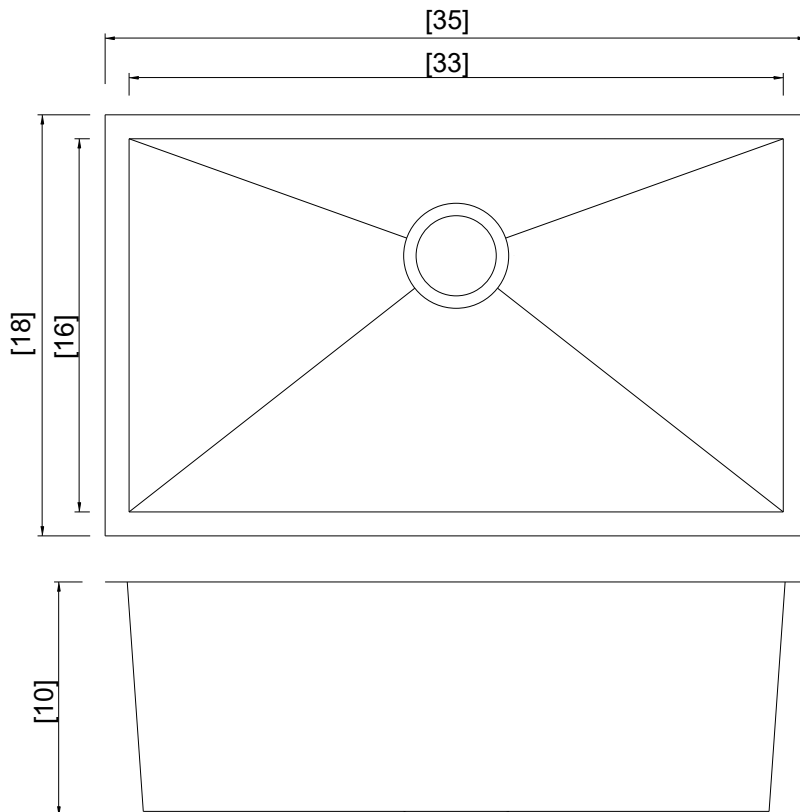

Allora USA Limited Lifetime Warranty

See website for details www.allorausa.com

ALLORA USA NOTES / DISCLAIMER:

All technical data provided is done as a service to customers of Allora USA and the end users of our products. Allora USA is not responsible for, nor does it have any liability for any mistakes or typographical errors including liability for incidental, consequential or special damages. Allora USA recommends that the model to be installed be present, inspected and measured prior to utilizing the related spec sheets and any work, preparations or alterations are made to any counter-top material. Nothing contained on this site is to be construed as contractual or providing any form of warranty or representation on the part of Allora USA. ALLORA USA MAKES NO WARRANTIES, EXPRESS OR IMPLIED, INCLUDING BUT NOT LIMITED TO ANY WARRANTY OF MERCHANTABILITY OR OF FITNESS FOR A PARTICULAR PURPOSE, AS TO THE INFORMATION CONTAINED HEREIN OR THE PRODUCTS DESCRIBED HEREIN.



ADDRESS: 22713 COMMERCE CENTER COURT STE 140 DULLES, VA 20166
PHONE: 571-291-3484
WEBSITE: WWW.ALLORAUSA.COM